

RAFS400-110A48 DC-DC Converter

Input 66V-160V, Output 48V/8.3A, Full-Brick Series

Contents

Features..... 1
 Ordering Information..... 1
 Outline Diagram 2
 Specifications..... 2
 Characteristic Curves..... 4
 Design Considerations 6
 Basic Connection 6
 Recommended Layout 6
 Input Voltage Range..... 7
 External Capacitance 7
 Remote Control..... 7
 Output Voltage Adjust..... 7
 Remote Sense..... 8
 Over Temperature Protection 8
 Output Over Voltage Protection 9
 EMC Consideration 9
 Safety Consideration..... 9
 Product Installation 9
 Delivery Package Information 10
 ESD Control..... 10
 Quality Statement 10
 Contact Information..... 10



Features

- ◆ Full Brick (116.8mm×61.0mm×12.7mm)
- ◆ Input Under Voltage Protection (55V to 65V turn off)
- ◆ Positive Logic Control (3.5V to 15V turn on)
- ◆ Output Over Voltage Protection (57.6V to 67.2V)
- ◆ Output Voltage Adjust Range:±10 % of the rated output voltage
- ◆ Output Short-circuit Protection, hiccup, auto-recovery
- ◆ High efficiency, 89% (110V, Full Load)
- ◆ 1500Vac Isolation Voltage
- ◆ Baseplate Temperature :-40°C to 100°C
- ◆ 115°C Typ Over Temperature Protection(OTP)
- ◆ Meets Requirements Of Standard EN 50155
- ◆ Applications: railway application

Ordering Information

See Contents for individual product ordering numbers.

Suffix	Meaning	Ordering Model
—	Basic Model	RAFS400-110A48
P	Negative Logic Control. Turn off when CNT pin is applied to 3.5~15V voltage or kept floating; Turn on when CNT pin is applied to -0.3V~1.5V voltage	RAFS400-110A48P

RAFS400-110A48 DC-DC Converter

Input 66V-160V, Output 48V/8.3A, Full-Brick Series

Outline Diagram

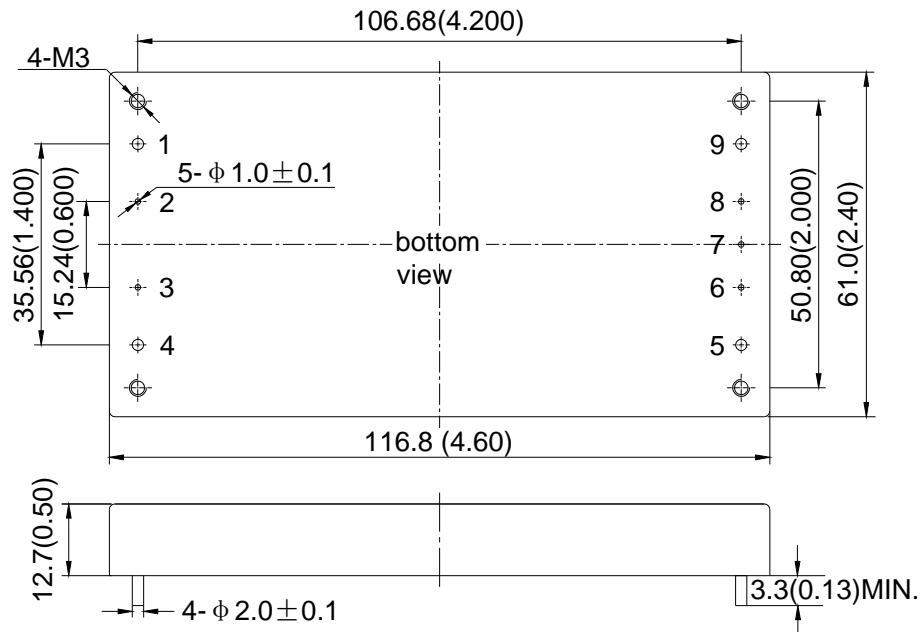

Pin	Symbol	Function	
1	-Vin	Negative Input	Case material: black flame retardant Plastic Pin: copper with gold plating Aluminum baseplate can be connected to Protective Earth pin by M3 screw. Notes: all dimensions in mm(inches) Tolerances: X.X±0.5(X.XX±0.02) X.XX±0.25(X.XXX±0.010)
2	CASE	Connect to the baseplate	
3	CNT	Remote Control, turn on/off the converter. Output voltage on when CNT floating or high level applied	
4	+Vin	Positive Input	
5	+Vo	Positive Output	
6	+S	Positive Remote Sense, connected to +Vo pin when not in use	
7	TRIM	Output Voltage Trim, voltage be trimmed up or down by applying external resistor connected to +S or -S output	
8	-S	Negative Remote Sense, connected to -Vo pin if not used	
9	-Vo	Negative Output	

Specifications

Unless otherwise specified, all tests are at room temperature and standard atmosphere, pure resistive load and basic connection.

Input	Symbol	Min	Typ	Max	Unit	Conditions
Input Voltage	V _{in}	66	110	160	V	—
Input current	I _{in}	—	—	7.0	A	V _{in} =66V, full load
Positive Logic Remote Control	ON	—	3.5	—	15.0	V Refer to -V _{in} ; Turn on when CNT floating
	Input current	—	—	—	1.0	mA CNT sink current when high level turn on
	OFF	—	-0.3	—	1.5	V Refer to -V _{in}
	Output current	—	—	—	1.0	mA CNT source current when turn off

Continue

RAFS400-110A48 DC-DC Converter

Input 66V-160V, Output 48V/8.3A, Full-Brick Series

Input	Symbol	Min	Typ	Max	Unit	Conditions	
Negative Logic Remote Control	ON	—	-0.3	—	1.5	V	Refer to $-V_{in}$
	Output current	—	—	—	1.0	mA	CNT source current when turn on
	OFF	—	3.5	—	15.0	V	Refer to $-V_{in}$; Turn off when CNT floating
	Input current	—	—	—	1.0	mA	CNT sink current when high level turn off
Start-up Delay Time	T_{delay}	—	—	400	ms	$V_{in}=110V, I_o=8.3A$	
Under Voltage Threshold	V_{UVLO}	55	—	65	V	—	
Under Voltage Threshold Hysteresis	ΔV_{UVLO}	3	—	5	V	—	

Output	Symbol	Min	Typ	Max	Unit	Conditions
Output Power	P_o	0	—	400	W	—
Output Voltage	V_o	47.52	48.00	48.48	V	—
Output Current	I_o	0.16	—	8.30	A	—
Output Voltage Adjust Range	V_{trim}	43.2	—	52.8	V	$I_o \leq 8.3A$ $P_o \leq 400W$
Line Regulation	S_V	—	—	± 0.2	% V_o	$V_{in}: 66V \sim 160V, I_o=8.3A$
Load Regulation	S_I	—	—	± 0.5	% V_o	$V_{in}=110V, I_o: 0.16A \sim 8.3A$
Output Overshoot	V_{TO}	—	—	± 10	% V_o	—
OVP Set Point	$V_{ov,set}$	57.6	—	67.2	V	—
Output Overcurrent Protection Set Point	$I_{o,lim}$	8.7	—	14.1	A	—
Output Short-circuit Protection	Hiccup mode, automatic recovery					
Peak to Peak Ripple and Noise	ΔV_{pp}	—	—	300	mV	20MHz bandwidth, Output equipped 100 μ F tantalum capacitor and 1 μ F ceramic capacitor
Rise Time	T_{rise}	—	—	10	ms	$I_{o,max}$, Pure resistive load
Capacitive Load Range	C_o	100	—	2000	μ F	—
Load Transient	Recovery Time	t_{tr}	—	200	μ s	Load change: 25%~50%~25% & 50%~75%~50% Current change: 0.1A/ μ s
	Voltage Deviation	ΔV_{tr}	—	± 1440	mV	

General	Symbol	Min	Typ	Max	Unit	Conditions
Efficiency	η	87	89	—	%	$V_{in}=110V, I_{o,nom}$
Switching Frequency	f_s	—	200	—	kHz	—
Isolation Resistance	R_{iso}	50	—	—	M Ω	—
MTBF	—	—	2×10^6	—	h	BELLCORE TR-332
Operating Baseplate Temperature	—	-40	—	100	$^{\circ}C$	—

Continue

RAFS400-110A48 DC-DC Converter

Input 66V-160V, Output 48V/8.3A, Full-Brick Series

General	Symbol	Min	Typ	Max	Unit	Conditions
Isolation Voltage	V _{iso}	1500	—	—	Vac	Input to output Leakage current ≤ 3mA
		1500	—	—	Vac	Input to case Leakage current ≤ 3mA
		500	—	—	Vac	Output to case Leakage current ≤ 3mA
Baseplate Temperature	—	-40	—	100	°C	—
Storage Temperature	—	-55	—	+125	°C	—
Temperature Coefficient	S _T	—	—	±0.02	%/°C	—
Over Temperature Protection	T _{ref}	100	115	120	°C	See Derating
Over Temperature Protection Hysteresis	ΔT _{ref}	—	10	—	°C	
MTBF	—	—	2×10 ⁶	—	h	BELLCORE TR-332
Vibration	Sine, Frequency:10Hz-55Hz, Amplitude:0.35mm, 30 min in each of 3 perpendicular directions					
Shock	Half sine, peak acceleration:300m/s ² , duration:6 ms ; continuous 6 times of pulse in each of 3 perpendicular directions					
Hand Soldering	Maximum soldering Temperature < 425°C, and duration < 5s					
Wave Soldering	Maximum soldering Temperature < 250°C, and duration < 10s					
Weight	—	—	142	—	g	—

Characteristic Curves

Load Transient Response

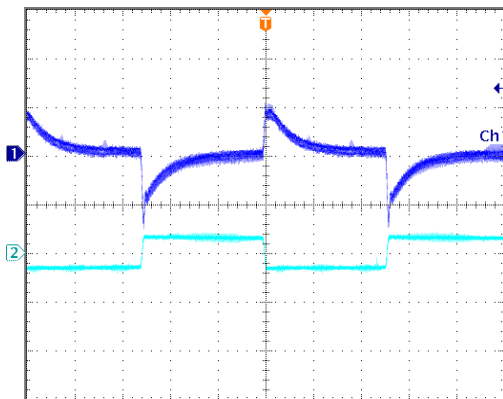

Load change: 25% ~ 50%
 ~25% I_{o,nom}, 0.1A/μs
 V_{in}=110Vdc

Trace1: 200mV/div
 Trace2: 3A/div
 Time scale: 0.4 ms/div

Load Transient Response

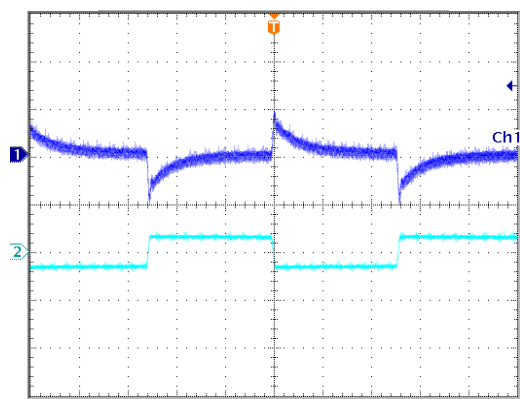

Load change: 50 ~ 75%
 ~50% I_{o,nom}, 0.1A/μs
 V_{in}=110Vdc

Trace1: 200mV/div
 Trace2: 3A/div
 Time scale: 0.4ms/div

RAFS400-110A48 DC-DC Converter

Input 66V-160V, Output 48V/8.3A, Full-Brick Series

Output Ripple and noise

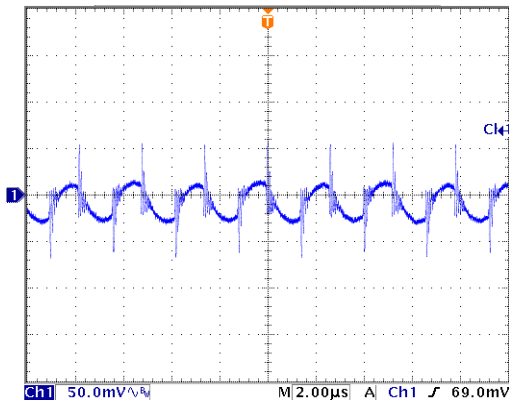

Start-up Delay Time

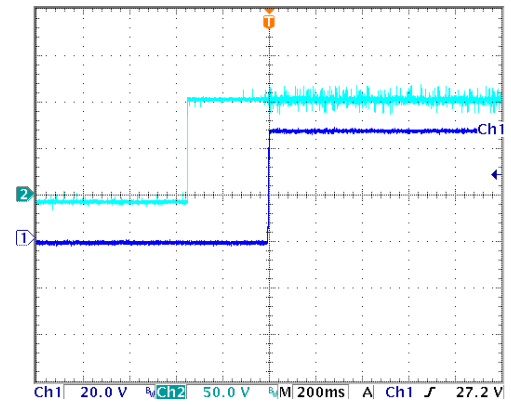

Rise Time

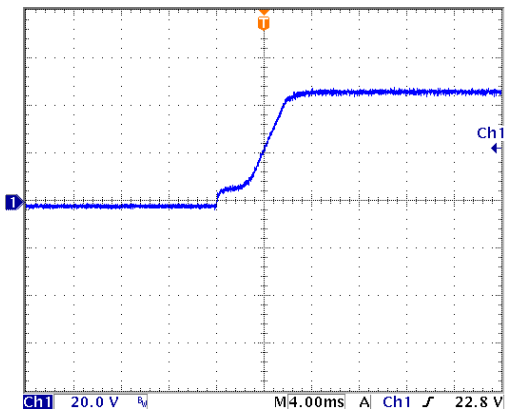

Turn-off

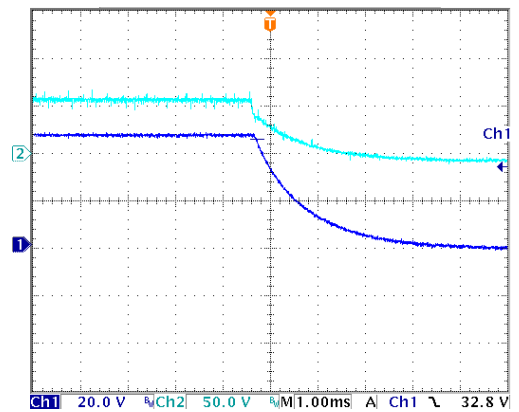

Derating

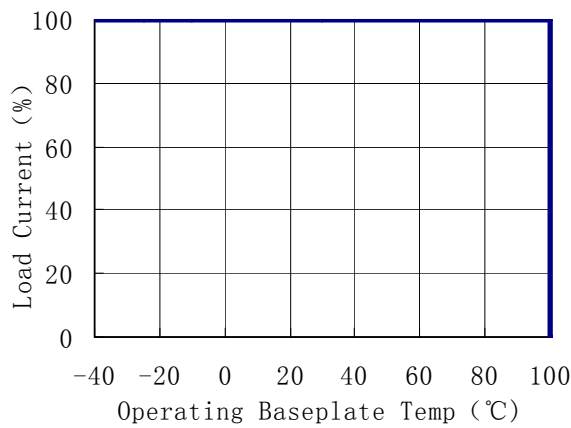

Efficiency vs Temperature and current

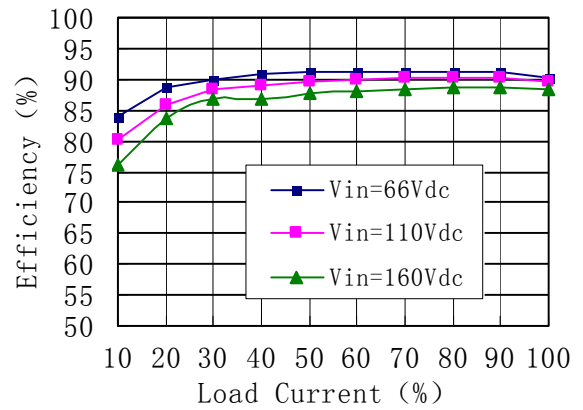

RAFS400-110A48 DC-DC Converter

Input 66V-160V, Output 48V/8.3A, Full-Brick Series

Design Considerations

Basic Connection

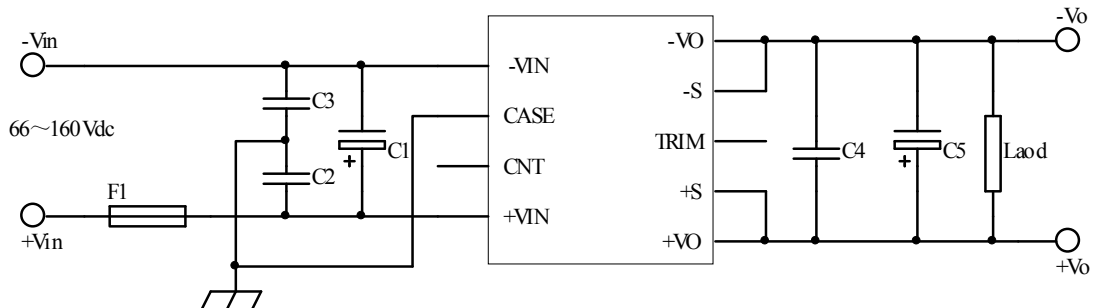

The recommended parameters in the circuit are as follows:

F1:15A,fast recovery.

C1:47μF electrolytic capacitor with low ESR, when ambient temperature below -20°C or input lines have greater inductance, two 47μF electrolytic capacitors should be paralleled.

C2\C3:330pF high-voltage ceramic capacitors, withstand voltage >3kVdc, the wire connected to the case should be as short as possible.

C4:1uF ceramic capacitor.

C5:100μF electrolytic capacitor, when ambient temperature below-20°C, two capacitors with 100μF should be paralleled.

Notes: The basic connection indicates the basic requirements. Please refer to the instruction followed for further information.

Recommended Layout

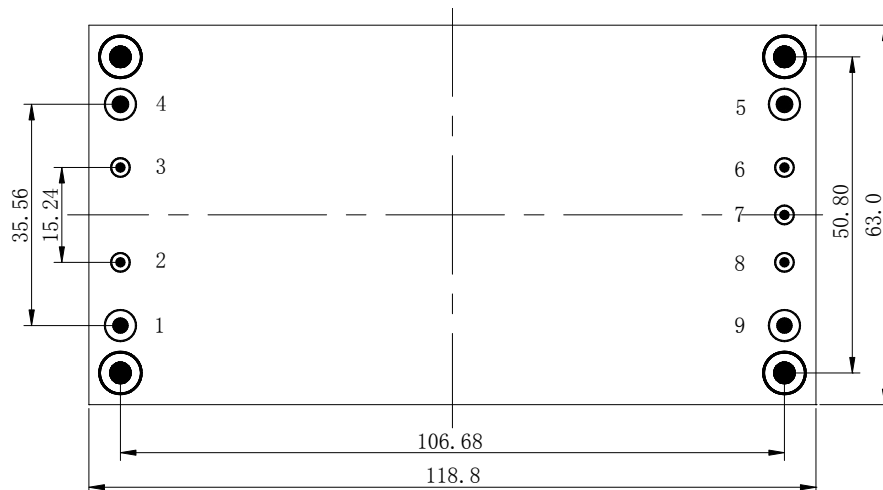

NO.	Recommendation & Notes
Pad Design	2、3、6、7、8 Pad holes: 1.5mm, pad diameter including hole:2.5mm; Pad hole 1、4、5、9 are 2.5mm,pad diameter including hole:4.50mm; the fixed holes at the four corners are metallized, with diameter of 4.1mm, pad diameter 8.5 mm within as prohibited wiring area.
Airflow Direction	The air should flow along the direction of the heat sink. perpendicular direction is not recommended.
Safety	Isolated Converters, care to the spacing between input and output, input and protective ground、 output and protective ground.
Electrical	The Vin(-) and Vo(-) planes should be placed under of the converter separately. Avoid routing sensitive signal or high disturbance AC signal under the converter.

RAFS400-110A48 DC-DC Converter

Input 66V-160V, Output 48V/8.3A, Full-Brick Series

Input Voltage Range

The input voltage range of the DC/DC converter is 66Vdc~160Vdc. The input impedance of the converter looks like a negative resistor, which can interact with the reactance of the power bus (including any filter elements that have been added to the input of the converter), causes an unstable condition.

The method to determine whether the impedance of the power bus too high or not is to decrease the converter’s input voltage from higher to lower gradually, if the output voltage decreases (unstable sometime) with the lower input voltage, it will be considered the impedance too large. For further confirmation, one electrolytic capacitor can be paralleled to the converter pins after the converter shuts down (one 1μF ceramic capacitor may be required to be paralleled with the electrolytic capacitor), if the output getting better, it will be sure that the impedance is too large.

External Capacitance

Unless special purpose (i.e. prolonging hold-up time, input impedance matching), the recommended input filter’s capacitance ranges 47μF~220μF, which not only offers a stable system, and reduces the cost, but also lessens the inrush current when the power supplies. When larger capacitance is required, a circuit of suppressing the inrush current is recommended when the regulator start-up and a discharge circuit is recommended when the output dropped, ensuring the reliability and safety of other equipments in the system.

Due to the output voltage of the product is relatively high and limited by the internal space, it needs additional capacitance to enable the system to work within the full load range. It is recommended that 100 μF aluminium electrolytic capacitors be connected in parallel at the output.

Remote Control

Remote control can be offered by setting right control voltage level to CNT pin. RAFS400-110A48 is provided with positive logic control, The circuit diagram is shown as “ internal circuit diagram for remote control power”.

When the level is higher than 3.5V and less than 15V or be left floating, the converter will turn on. When the level is less than 1.5V, the converter will turn off.

due to VD1 is signal diode, and the logic comparator is semiconductor integrated chip, it has low endurance to surge. Care should be taken to prevent CNT from surge, like application of TVS. When the pin floating, the voltage is 9V-11V, the VCC is supplied from internal power supply.

RAFS400-110A48P is provided with negative logic control, it has the same characteristic as RAFS400-110A48, except control logic. When the level is higher than 3.5V and less than 15V or be left floating, the converter will turn off. When the level is less than 1.5V, the converter will turn on. like the positive logic control converters, care should be taken to prevent CNT from the surge.

In some applications, extra controls will be designed for the converter in user’s PCB, such as output short circuit protection, over voltage protection, under voltage protection, synchronous control to the converter output voltage, and so on, remote control will give you help. The controls can be achieved by external circuit applied to the CNT pin.

When the signal from the system is beyond 3.5V-15V, or it can be enabled only within a very narrow control level (Requested to turn-off between 5.0V-5.5V), the aux circuit will be required. Please contact Yihongtai for more information.

Output Voltage Adjust

The converters have an Output Voltage adjust pin (Trim). This pin can be used to adjust the output voltage above or below Output voltage initial setting. The maximum value of the trimmed up is 20%, Even +S and -S pins are used to compensate the voltage simultaneously, the sum of the trimmed up and the

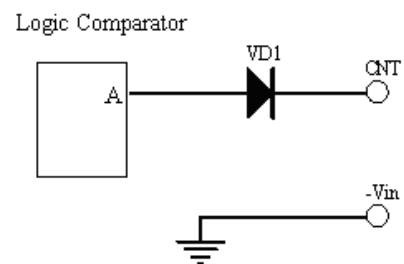

Internal circuit diagram for remote control power

RAFS400-110A48 DC-DC Converter

Input 66V-160V, Output 48V/8.3A, Full-Brick Series

compensation should not be more than 10%, or the characteristics will not be assured in compliant with the specification, even the over voltage protection may be triggered. The output power can not exceed 400W at increased output voltages. and the output current can not exceed 8.3A. at decrease output voltages. When the trim pins are not used, they should be floated

External circuit is connected as the figure shown, the resistance is calculated as the formula below, please note that the formula will be invalid when $R_{Trim-up}$ 、 $R_{Trim-down}$ are used simultaneously, users adjust the value based on the resistance applied.

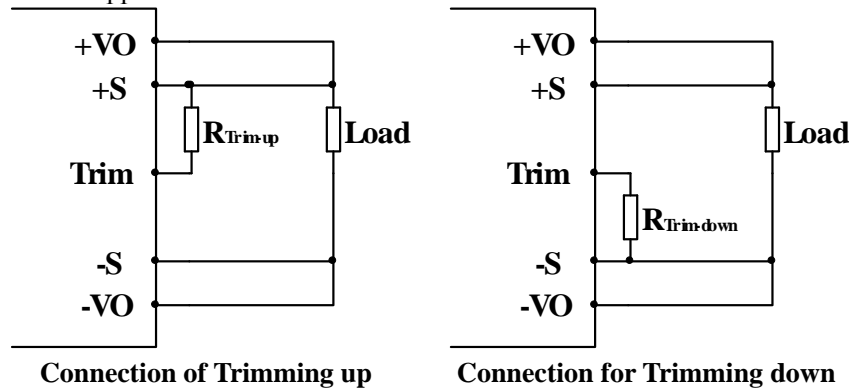

Resistance for trimming up:

$$R_{Trim-up} = \left(\frac{Vo(100(\%) + \Delta(\%))}{1.225 \times \Delta(\%)} - \frac{100(\%) + 2\Delta(\%)}{\Delta(\%)} \right) (k\Omega)$$

Resistance for trimming down:

$$R_{Trim-down} = \left(\frac{100(\%)}{\Delta(\%)} - 2 \right) (k\Omega)$$

$R_{trim-up}$ 、 $R_{trim-down}$:Resistance for trimming up or down, $k\Omega$;

Vo :rated The output voltage you need, This product is 48V;

ΔV :The output voltage Change (The output voltage you need minus output voltage);

Remote Sense

The remote sense can be used to compensate for the voltage drop between the output pins of the converter and the load input pins by +S、-S pins. The +S and -S pins should be connected to the input pins of the load respectively. The remote sense circuit will compensate for up to 10% voltage drop between the sense voltage and the voltage at the output pins.

The anti-interference design should be considered when the +S、-S pins are connected to the pins to be compensated. The +S、-S traces should be located close to a ground trace or ground plane, and the area they surrounded should be minimized (just for electrical isolation); If cable connection presents, twisted pair wires should be used, EMI core are equipped with the twisted pair wires to reduce common mode noise when necessary, the sense leads should not be longer than 200mm, or the system characteristics may not be assured.

The sense leads only can carry very little current, and are not used for converter power output. Care should be taken in operation to avoid damaging the converter.

Over Temperature Protection

The over temperature protection feature is used to protect the converter, and the sensor locates in the baseplate. If the temperature of the baseplate exceeds the threshold of 115°C, the converter will shut down, The converter will stop until safe operating temperature is restored. Hysteresis temperature between OTP trig point and restart is approx 10°C. Time between OTP and restart is dependent on cooling of DC/DC converter.

RAFS400-110A48 DC-DC Converter

Input 66V-160V, Output 48V/8.3A, Full-Brick Series

Output Over Voltage Protection

The switching-off type over voltage protection feature is used to protect the converter, when output voltage exceeds 120% to 140% of the rated output voltage (the set point is between 120%-140%, there is the difference based on the specific parameters, but not beyond the range), the output voltage will shut down. When the converter internal detection circuit detect abnormal signals disappear the output will recovery.

EMC Consideration

Conductive Interference will be emphasized in the following consideration, surge、EFT、conducted interference generated from the converter to power supply system, and so on. Some tests, like static, radiation, should be considered in the whole system design.

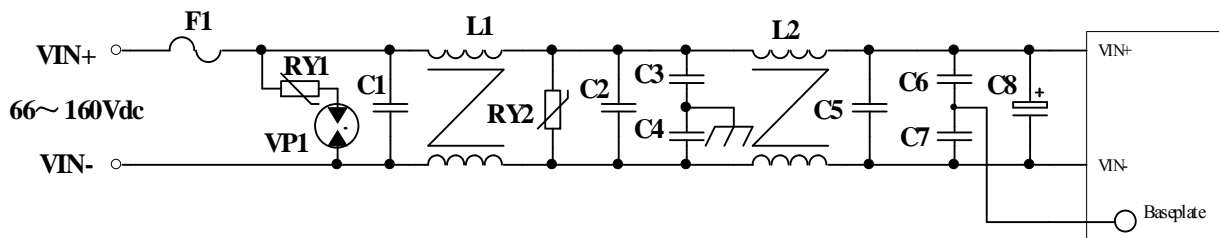

RY1、RY2、VP1 in the figure are VDR and discharge tube respectively, for the suppression of the differential mode interference conducted along with the wire. The maximum surge current of the VDR and Impulse Discharge Current of the discharge tube, I_{max} should not less than 3KA, Varistor voltage or DC Spark over Voltage: 220V to 275V. For lower level protection, RV2 can be remained only. It is advised to remain L1, if not, the differential mode inductor should be set, or others to make sure inductive resistance exists in the circuit, for a longer life to RY2.

The function of L1、L2、C1 to C7 is for filtering differential mode and common mode interference. L1&L2 are for low frequency and high frequency separately. If only one common mode choke is required to remain for some reasons, the impedance characteristic of input voltage source should be considered comprehensively, L2 may be removed for low impedance and L1 may be removed for high impedance, the inductor for filtering within 10MHz should be focused on.

Safety Consideration

The converter, as one component for the end user, should be installed into the equipment, and all the safety considerations are achieved under certain condition. It is required to meet safety requirements in system design for the user. The primary to secondary is basic insulation to EN60950. The maximum operating temperature for PCB is 130 °C.

To avoid fire and be protected when short circuit occurred, it is recommended that a fast blow fuse with rating 2.5-3 times of converter continuous input peak current is used in series at the input terminal. (Inrush current suppression circuit is required for greater filter capacitance at input terminal, or it will result in the misoperation of the fuse).

Product Installation

The product can be installed in user board, suggest using M3 screw to fix the products in user board, in order to enhance the bearing ability when impactive and vibration coming. Note that, when you hammer the product using screws, this product shall be first fixed, again a needle pin welding, prevent strain soldered dot. Moreover the biggest torque of fastening screw cannot exceed 0.6 N.m, otherwise it will likely damage. the structural related to studs.

Metal surface of this product structured by aluminum PCB which has good thermal conductivity, mapping the overburden with heat conduction conlents or thermal gaskets, then install proper radiator.

Proper radiator and flows through radiator wind will greatly enhance products cooling capacity. when you install radiator, you should be paid attention to the length of the bolt, ensure that has no relevant relatives with the screws fixed on PCB.

RAFS400-110A48 DC-DC ConverterInput 66V-160V, Output 48V/8.3A, Full-Brick Series

Delivery Package Information

Package material is multiple wall corrugated, internal material is anti-static foam, its surface resistance is from 105 Ω to 1012 Ω . Tray capacity: 2 \times 3=6 PCS/box, Tray weight: 0.9kg; Carton capacity: 15 \times 6=90PCS, Carton weight: 13.5kg.

ESD Control

The converters are processed and manufactured in an ESD controlled environment and supplied in conductive packaging to prevent ESD damage from occurring before or during shipping. It is essential that they are unpacked and handled using an ESD control procedures. Failure to do so affects the lifetime of the converter.

Quality Statement

The converters are manufactured in accordance with ISO 9001 system requirements, in compliant with EN50155, and are monitored 100% by auto-testing system, 100% burn in. The warranty for the converters is 5-year.

Contact Information

Anhui Hesion Trading Co.,Ltd.

Beijing Yihongtai Technology Dev.Co.,Ltd

TEL: +86-551-65369069,65369067

FAX:+86-551-65369070

Email: alecz@ahhesion.com

Backup:alecz@126.com