

WKD30-24S12 DC/DC Converter

Input 9V~36V Output 12V/2.5A 1in.×1in. Industry Standard Size

Contents

Outline Diagram 1
 Features 1
 Specifications 2
 Characteristic Curves 3
 Design Considerations 4
 Basic Connection 4
 Recommended Layout 5
 Input Voltage Range 5
 External Capacitance 5
 Remote Control 5
 Output Voltage Adjust 6
 Thermal Consideration 6
 Safety Consideration 6
 Series and Parallel Operation 7
 ESD Control 7
 Cleaning Notice 7
 Delivery Package Information 7
 Quality Statement 7
 Contact Information 7



Outline Diagram

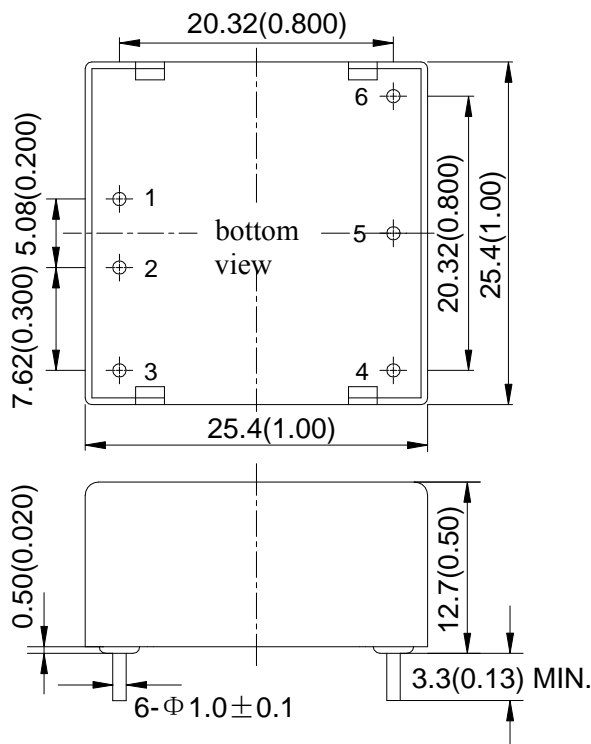

Features

- ◆ 1in.×1in. Industry Standard Size (25.4mm×25.4mm×12.7mm)
- ◆ Wide Input Voltage (9V~36V)
- ◆ Positive Logic Control(3.5V to 15V or CNT floating turn on)
- ◆ Output Voltage Adjust Range: ±10 % of the rated output voltage
- ◆ Output Over Current Protection (OCP)
- ◆ Output short-circuit protection, hiccup, auto-recovery
- ◆ High efficiency, 88% typ. (input 24V, $I_{o,max.}$)
- ◆ 1500Vdc Min. I/O Isolation Voltage
- ◆ Operating Case Temperature: -40 °C~+105 °C
- ◆ Operating Ambient Temperature: -40 °C~+55 °C
- ◆ Applications: Telecom/ Datacom system equipments and Railway & Rail transit ,Industrial control equipments and Instruments.

Pin	Symbol	Function
1	+Vin	Positive Input
2	-Vin	Negative Input
3	CNT	Remote Control Pin
4	-Vo	Negative Output
5	TRIM	Regulations Of Output
6	+Vo	Positive Output

Case material: Aluminum, black
 Pins material: Copper with gold plating
 Notes: all dimensions in mm(inches)
 X.X±0.5 (X.XX±0.02)
 X.XX±0.25 (X.XXX±0.010)

WKD30-24S12 DC/DC Converter

Input 9V~36V Output 12V/2.5A 1in.×1in. Industry Standard Size

Specifications

Unless otherwise specified, all tests are at room temperature and standard atmosphere, pure resistive load.

Input		Symbol	Min	Typ	Max	Unit	Conditions
Input Voltage		V_{in}	9	24	36	V	—
Input Current		I_{in}	—	—	4	A	$V_{in}=9V, I_o=2.5A$
Input Idling Current		$I_{in,nl}$	—	—	40	mA	$V_{in}=9V, I_o=0A$
Positive Logic Remote Control	ON	—	3.5	—	15.0	V	Refer to $-V_{in}$ Also turn on when CNT floating
	Current	—	—	—	0.5	mA	CNT sink current when turn on
	OFF	—	0	—	1.5	V	Refer to $-V_{in}$
	Current	—	—	—	1.0	mA	CNT source current when turn off
Start-up Delay Time		T_{delay}	—	10	—	ms	—

Output		Symbol	Min	Typ	Max	Unit	Conditions
Output Voltage		V_o	11.88	12.00	12.12	V	—
Output Current		I_o	0	—	2.5	A	$V_{in}=9V, 90\%I_o=2.25A$
Output Voltage Adjust Range		V_{trim}	10.8	—	13.2	V	$I_o \leq 2.5A, P_o \leq 30W$
Line Regulation		S_V	—	—	± 0.2	$\%V_o$	$V_{in}: 9V \sim 36V, I_o=2.5A$
Load Regulation		S_I	—	—	± 0.5	$\%V_o$	$V_{in}=24V, I_o: 0 \sim 100\% I_{o,nom}$
Over Current Protection Level		$I_{o,lim}$	110	—	170	$\%I_o$	$V_{in}=24V$
Over-shoot		V_{TO}	0	—	± 5	$\%V_o$	$V_{in}=24V, \text{ pure resistive load}$
Output Short-circuit Protection		hiccup, auto-recovery					
Peak to Peak Ripple and Noise		ΔV_{pp}	—	—	100	mV	20MHz bandwidth
Rise Time		T_{rise}	—	5	—	ms	$V_{in}=24V, \text{ pure resistive load}$
Capacitive Load Range		C_o	0	—	1000	μF	pure resistive load
Load Transient	Recovery Time	t_{tr}	—	—	200	μs	$25\% \sim 50\% \sim 25\% I_{o,max}$ or $50\% \sim 75\% \sim 50\% I_{o,max};$ 0.1A/ μs
	Voltage Deviation	ΔV_{tr}	—	—	± 600	$\%V_o$	

General		Symbol	Min	Typ	Max	Unit	Conditions
Efficiency		η	85	88	—	%	$V_{in}=24V, I_o=2.5A$
Switching frequency		f_s	—	350	—	kHz	—
MTBF		—	—	2×10^6	—	h	BELLCORE TR-332
Isolation Resistance		R_{iso}	50	—	—	M Ω	—

WKD30-24S12 DC/DC Converter

Input 9V~36V Output 12V/2.5A 1in.×1in. Industry Standard Size

Continue

General	Symbol	Min	Typ	Max	Unit	Conditions
Isolation Voltage	V_{iso}	1500	—	—	Vdc	Input to output
Operating Ambient Temperature	—	-40	—	+55	°C	—
Operating Case Temperature	—	-40	—	+105	°C	—
Storage Temperature	—	-55	—	+125	°C	—
Temperature Coefficient	S_T	—	—	±0.02	%/°C	—
Hand Soldering	Maximum soldering Temperature < 425°C, and duration < 5s					
Wave Soldering	Maximum soldering Temperature < 255°C, and duration < 10s					
Weight	—	—	17	—	g	—

Characteristic Curves

Load Transient Response

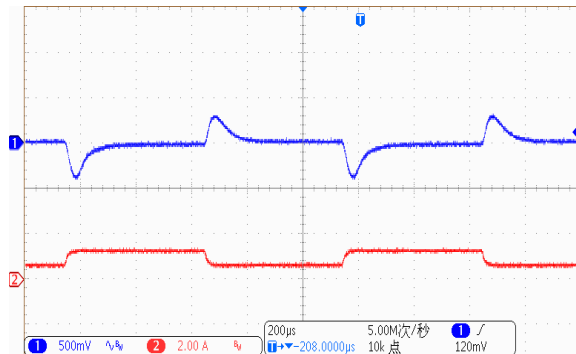

Load change: 25%~50%
 50%~25% $I_{o,nom}$,
 0.1A/ μ s, V_{in} =24Vdc
 Trace1: 500mV/div
 Trace2: 2.0A/div
 Timescale:0.2ms/div

Load Transient Response

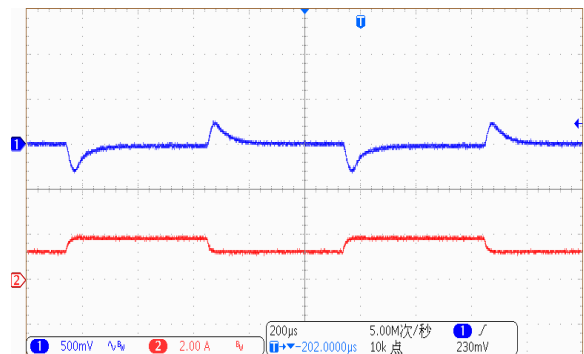

Load change: 50%~75%
 75%~50% $I_{o,nom}$,
 0.1A/ μ s, V_{in} =24Vdc
 Trace1: 500mV/div
 Trace2: 2.0A/div
 Timescale:0.2ms/div

Output Ripple

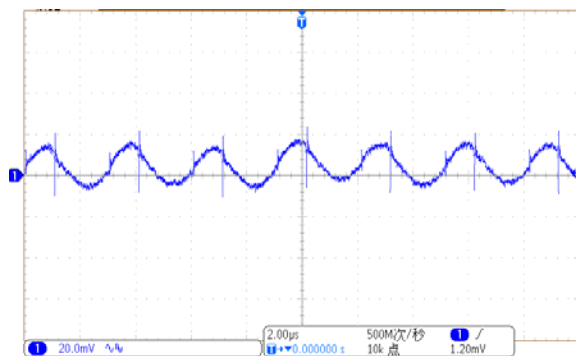

V_{in} =24Vdc, I_o =2.5A(20MHz)

Start-up Delay Time

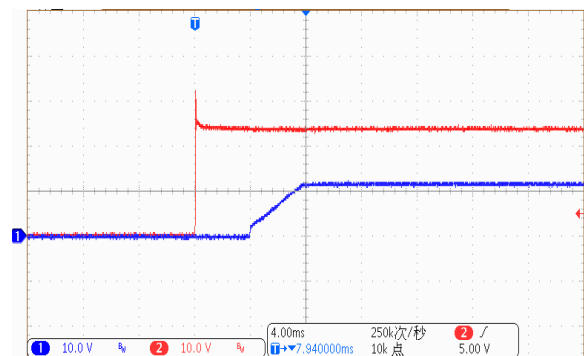

V_{in} =24Vdc, I_o =2.5A(20MHz)

WKD30-24S12 DC/DC Converter

Input 9V~36V Output 12V/2.5A 1in.×1in. Industry Standard Size

Rise time

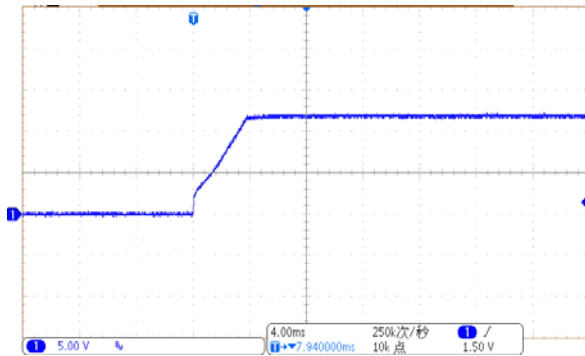

$V_{in}=24Vdc, I_o=2.5A(20MHz)$

Turn-off

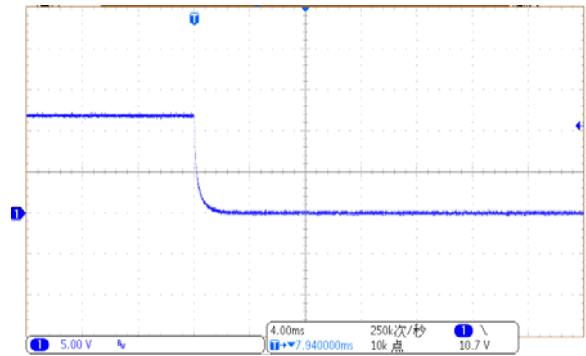

$V_{in}=24Vdc, I_o=2.5A(20MHz)$

Derating Curves

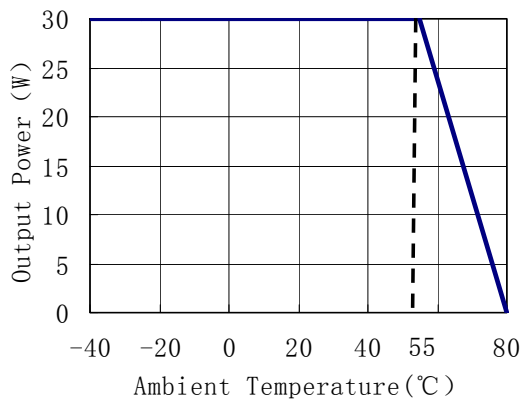

Efficiency vs. Io & Vin

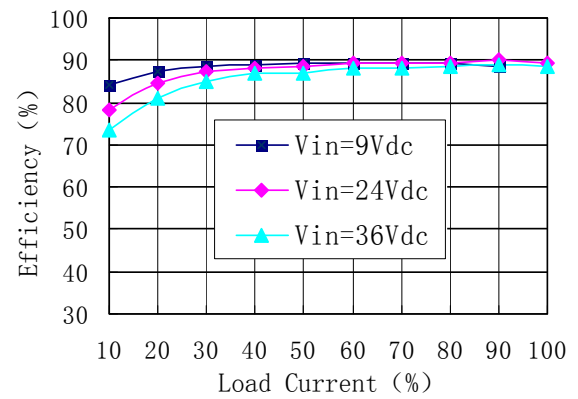

Design Considerations

Basic Connection

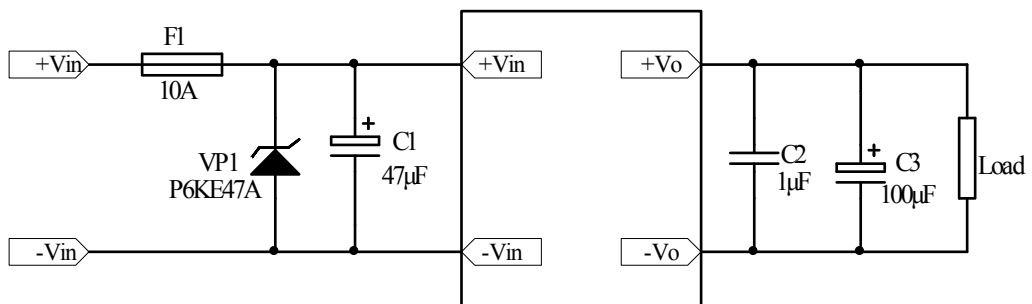

Notes: Please see the application information followed for the further information.

WKD30-24S12 DC/DC Converter

Input 9V~36V Output 12V/2.5A 1in.×1in. Industry Standard Size

Recommended Layout

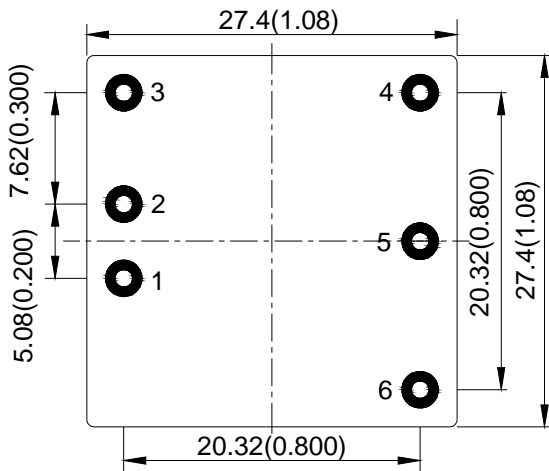

NO.	Recommendation & Notes
Pad Design	Pad holes 1.2mm, pad diameter including hole:2.5mm
Mounting Direction	Heatsink face up, for natural convection
Safety	Isolated Converters, care to the spacing between input and output
Electrical	The Vin(-) and Vo(-) planes should be placed under of the converter separately. Avoid routing sensitive signal or high disturbance AC signal under the converter

Input Voltage Range

The input voltage range of the DC/DC converter is 9V to 36V, The input impedance of the converter looks like a negative resistor, which can interact with the reactance of the power bus (including any filter elements that have been added to the input of the converter), causes an unstable condition. Depending on the internal transformer's impedance, the source impedance of the Power bus should be kept as low as possible.

The method to determine whether the impedance of the power bus too high or not is to decrease the converter's input voltage from higher to lower gradually, if the output voltage decreases (unstable sometime) with the lower input voltage, it will be considered the impedance too large. For further confirmation, one electrolytic capacitor can be paralleled to the converter pins after the converter shuts down (one 1μF ceramic capacitor may be required to be paralleled with the electrolytic capacitor), if the output getting better, it will be sure that the impedance is too large.

External Capacitance

Unless special purpose (i.e. prolonging hold-up time, input impedance matching), the recommended input filter's capacitance ranges 47μF to 100μF, which not only offers a stable system, and reduces the cost, but also lessens the inrush current when the power supplies.

When larger capacitance is required, a circuit of suppressing the inrush current is recommended when the regulator start-up and a discharge circuit is recommended when the output dropped, ensuring the reliability and safety of other equipments in the system.

Remote Control

Remote control can be offered by setting right control voltage level (floating, high resistance) to CNT pin. When the level is higher than 3.5V or be left floating, the converter will be on. when the level is lower than 1.5V, the converter will be off.

WKD30-24S12 is provided with positive logic remote control. The circuit diagram is shown as "internal circuit diagram for positive logic control". when low level applied, the CNT source current is less than 1mA. due to VT1 is signal Triode, and the logic comparator is semiconductor integrated chip with low resistance to surge. Care should be taken to prevent CNT from surge, A TVS should be used in some cases.

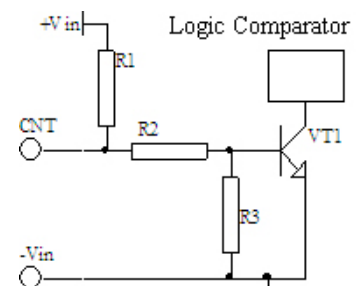

Internal circuit diagram for positive logic control

In some applications, extra controls will be designed for the converter in user's PCB, such as output short circuit protection, over voltage protection, under voltage protection, and so on, remote control will give you help. The controls can be achieved by external circuit applied to the CNT pin.

WKD30-24S12 DC/DC Converter

Input 9V~36V Output 12V/2.5A 1in.×1in. Industry Standard Size

In some applications it is necessary to have a precise turn on and turn off level, or the level which can be received has a very narrow range, (such as turn-on between 5.0V-5.5V), the aux. circuit will be required. Please contact us for more information.

Output Voltage Adjust

The converters have an Output Voltage adjust pin (Trim). This pin can be used to adjust the output voltage above or below Output voltage initial setting. When increasing the output voltage, the voltage at the output pins (including any remote sense offset) must be kept below the maximum output adjust range, or the characteristics will not be assured in compliant with the specification, even the over voltage protection may be triggered. Also note that at increased output voltages the maximum power rating of the converter 30W remains the same, and the output current capability will decrease correspondingly, at decrease output voltages the maximum current should not exceed 2.5A. When the trim pin is not used, it should be floated. External circuit is connected as the figure shown, the resistance is calculated as the formula below, please note that the formula will be invalid when $R_{Trim-up}$ 、 $R_{Trim-down}$ are used simultaneously, users adjust the value based on the resistance applied.

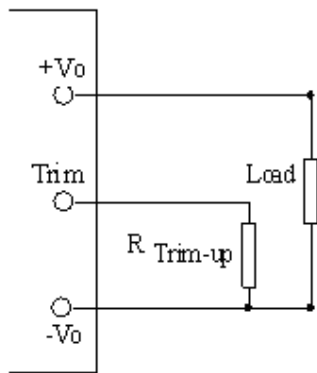

Connection for Trimming Up

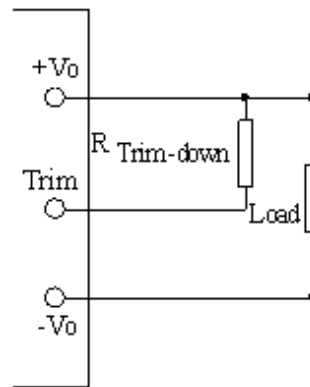

Connection of Trimming Down

Resistance for trimming up : $R_{Trim-up} = \left(\frac{23.73}{\Delta V} - 7.5 \right) (k\Omega)$

Resistance for trimming down: $R_{Trim-down} = \left(\frac{7.56V_o - 9.53\Delta V}{\Delta V} - 7.5 \right) (k\Omega)$

V_o : rated output voltage, 12V;

ΔV_o : Change rate, divide output voltage by rated output voltage;

$R_{Trim-up}$ 、 $R_{Trim-down}$: Resistance for trimming up or down,k Ω .

Thermal Consideration

The converters operate in a variety of thermal environments. however, sufficient cooling should be provided to ensure reliable operation of the unit. Heat is removed by conduction, convection and radiation to the surrounding environment.

When case temperature is higher than the permitted operating, the derating curves should be referred or external heat dissipation measures. Forced air cooling or heatsink should be used. The air tunnel should be considered for forced air cooling to avoid heated air be hindered or forming swirl. When heatsink used, it should be attached the converter closely through double-side thermal conductivity insulation adhesive or thermal conductivity silicone for heat exchange.

Safety Consideration

The converter, as a component for the end user, should be installed into the equipment, and all the safety considerations are achieved under certain condition. It is required to meet safety requirements in system design. The converter output is considered SELV, and the expected input is considered TNV2, the primary to secondary is basic insulation to EN60950. The maximum operating temperature for PCB is 130°C.

WKD30-24S12 DC/DC ConverterInput 9V~36V Output 12V/2.5A 1in.×1in. Industry Standard Size

To avoiding fire and be protected when short circuit occurred, it is recommended that a fast blow fuse with rating 2.5 to 3 times of converter's continuous input peak current is used in series at the input terminal.(Inrush current suppression circuit is required for greater filter capacitance at input terminal, or it will result in the misoperation of the fuse).

Series and Parallel Operation

The converters should not be paralleled directly to increase power, but they can be paralleled each other through o-ring switches or diodes. Make sure that every converter's maximum load current should not exceed the rated current at anytime if they are paralleled without using external current sharing circuits.

The converters can operate in series. To prevent against start-up failure due to start up time difference, SBD with low voltage difference can be paralleled at the output pins(SBD negative terminal connect to the positive pin of the output) for each converter.

ESD Control

The converters are processed and manufactured in an ESD controlled environment and supplied in conductive packaging to prevent ESD damage from occurring before or during shipping. It is essential that they are unpacked and handled using an ESD control procedures. Failure to do so affects the lifetime of the converter.

Cleaning Notice

The converter case is not a hermetically-sealed construction, a sufficient drying process is required after the converter cleaning, make sure the liquid congregated is removed, or it will damage the converter or degradation of performance.

After surface treatment, the appearance of the converter may be affected by the organic solvent, protection measures should be taken before cleaning when appearance is concerned.

Delivery Package Information

Package material is multiple wall corrugated with less than 10^{12} Ω surface resistance; internal material is anti-static foam with less than 10^5 Ω surface resistance. Tray capacity: $2 \times 32 = 64$ PCS/box , Tray weight:1.17kg; Carton capacity: $8 \times 64 = 512$ PCS, Carton weight:10.0kg.

Quality Statement

The converters are manufactured in accordance with ISO9001 system requirements, in compliant with YD/T1376-2005, and are monitored 100% by auto-testing system, 100% burn in.

The warranty for the converters is 5-year.

Contact Information

Anhui Hesion Trading Co.,Ltd.
& Beijing Yihongtai Technology Dev.Co.,Ltd

TEL: +86-551-65369069,65369067

Email: alecz@ahhesion.com

Backup:alecz@126.com

www.ahhesionpower.com